

Temposonics®

Magnetostrictive, Absolute, Non-contact
Linear-Position Sensors



E-Series Models EP and EL Synchronous Serial Interface (SSI) Output Data Sheet

Document Part Number:
551299 Revision B



Model EP position sensor - Full Size Profile Housing
Stroke Length: 50 mm to 2500 mm (or 2 in. to 100 in.)

Model EL position sensor - Low Height Profile Housing
Stroke Length: 50 mm to 2500 mm (or 2 in. to 100 in.)

FEATURES

- Linear, Absolute Measurement
- Non-Contact Sensing Technology
- Linearity Deviation Less Than 0.02% F.S.
- Repeatability Within 0.005% F.S.
- SSI Provides a High-Speed Noise Immune and Cost Effective Sensor Interface
- Stroke Length Range:
 - 50 mm to 2500 mm (or 2 in. to 100 in.)
- EMI Shielded and CE Certified

BENEFITS

- Resolution Down to 20 μm
- Rugged, Cost Effective, Precise and Durable
- Direct 24/25 Bit SSI Output, Gray/Binary Formats
- Over Voltage Protection to 36 Vdc and Polarity Protection up to -30 Vdc

APPLICATIONS

- Continuous Operation In Harsh Industrial Conditions

TYPICAL INDUSTRIES

- Factory Automation
- Woodworking and Metal Forming
- Material Handling and Packaging

Time-based Magnetostrictive position sensing principle

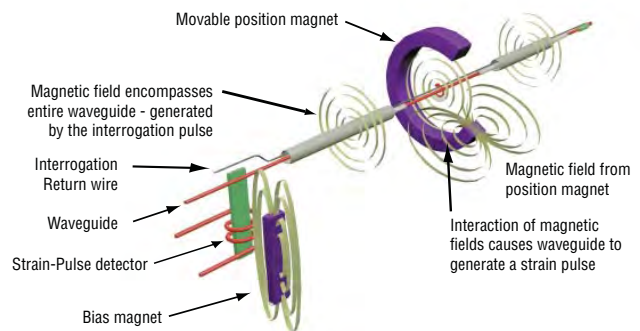

Benefits of Magnetostriction

Temposonics linear-position sensors use the time-based magnetostrictive position sensing principle developed by MTS. Within the sensing element, a sonic-strain pulse is induced in a specially designed magnetostrictive waveguide by the momentary interaction of two magnetic fields. One field comes from a movable permanent magnet that passes along the outside of the sensor. The other field comes from an “interrogation” current pulse applied along the waveguide. The resulting strain pulse travels at sonic speed along the waveguide and is detected at the head of the sensing element.

The position of the magnet is determined with high precision and speed by accurately measuring the elapsed time between the application of the interrogation pulse and the arrival of the resulting strain pulse with a high-speed counter. The elapsed time measurement is directly proportional to the position of the permanent magnet and is an absolute value. Therefore, the sensor's output signal corresponds to absolute position, instead of incremental, and never requires recalibration or re-homing after a power loss. Absolute, non-contact sensing eliminates wear, and guarantees the best durability and output repeatability.

All specifications are subject to change. Contact MTS for specifications and engineering drawings that are critical to your application. Drawings contained in this document are for reference only. Go to <http://www.mtssensors.com> for the latest product documentation and related media.

Sold & Serviced By:



Toll Free Phone (877) SERV098
Toll Free Fax (877) SERV099
www.electromate.com
sales@electromate.com

E-Series Models EP and EL Sensors Product Overview/Specifications

Product overview

MTS Sensors continues to establish new performance standards for low-cost, fully-industrial, durable position sensors using the widely preferred magnetostrictive technology. This principle for accurate and non-contact measurement of linear-position sensing was developed 30 years ago by MTS and is used with outstanding success in a large variety of industrial applications.

The Temposonics models EP and EL sensors consists of robust aluminum profile-style housings that offer flexible mounting configurations and easy installation. Sensor models EP and EL are ideal for demanding industrial applications where simple, reliable non-contact feedback is essential.

Product specifications

Parameters	Specifications	Parameters	Specifications
OUTPUT		ELECTRONICS	
Measured output variables:	Position	Operating voltage:	+24 Vdc nominal: -15% or +20% Polarity protection: ≥ -30 Vdc Over voltage protection: ≤ 36 Vdc Current drain: 90 mA Dielectric withstand voltage: 500 Vdc <i>(DC ground to machine ground)</i>
Resolution:	20 µm, 50 µm, 100 µm	ENVIRONMENTAL	
Update rate:		Operating conditions:	Operating temperature: -40 °C (-40 °F) to 75 °C (167 °F) Relative humidity: 90% no condensation Ingress protection: IP 67 <i>(when appropriate mating connector is correctly fitted)</i>
Measuring length:	300 750 1000 2000 mm	EMC test:	Electromagnetic emission: EN 61000-6-3 Electromagnetic immunity: EN 61000-6-2 <i>The sensor meets the requirements of the EC directives and is marked with CE.</i>
Measurements/Sec:	3.7 3.0 2.3 1.2 kHz	Shock rating:	100 g (single hit)/ IEC standard EN 60068-2-27
Linearity deviation:	< ± 0.02% full stroke (minimum ± 60 µm)	Vibration rating:	15 g/10 to 2000 Hz, IEC standard EN 60068-2-6 <i>(resonance frequencies causing excess of 10 g are excluded)</i>
Repeatability:	± 0.005% full stroke (minimum ± 20 µm)	WIRING	
Outputs:	Interface: Synchronous Serial Interface (SSI) (RS-422 type differential signal pairs) Data format: Binary or gray Data lengths: 24 or 25 bit Data speed (Baud rate): 70 kBd to 1 MBd, depending on cable length (see below):	Connection type:	8-pin (M12) male integral connector
Length:	<3 <50 <100 <200 <400 m	PROFILE-STYLE SENSOR	
Baud rate:	1.0 MBd <400 kBd <300 kBd <200 kBd <100 kBd	Electronic head:	Aluminum housing
Stroke length:	Range: 50 mm to 2500 mm (2 in. to 100 in.)	Sensor extrusion:	Aluminum (Temposonics profile style)
		Mounting positions:	Adjustable mounting clamps, Any orientation.
		Magnet types:	Captive-sliding magnet, block magnet or Open-ring magnet (for Model EP)

Sold & Serviced By:



Toll Free Phone (877) SERV098
Toll Free Fax (877) SERV099
www.electromate.com
sales@electromate.com

Synchronous Serial Interface (SSI)

Temposonics E-Series sensors with SSI fulfill all requirements of the SSI standard for an absolute encoder. The position value is encoded in a 24/25 code format and is transmitted at high speed in SSI standard format to the control device. The main feature of SSI is the synchronized data transfer. Data transfer synchronization simplifies the closed-loop control system. A clock pulse train from a controller is used to gate out sensor data. One bit of position data is transmitted to the controller for each clock pulse received by the sensor (see 'Figures 1 and 2'). The absolute position data is continually updated by the sensor and converted by the shift register into serial information. (see 'Figure 3').

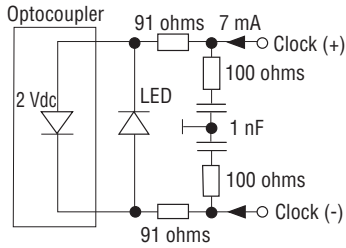

Figure 1. Sensor input

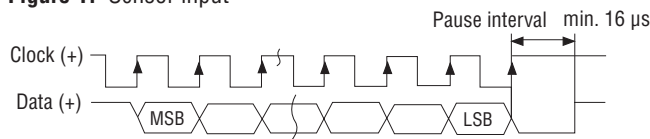

Figure 2. Timing Diagram

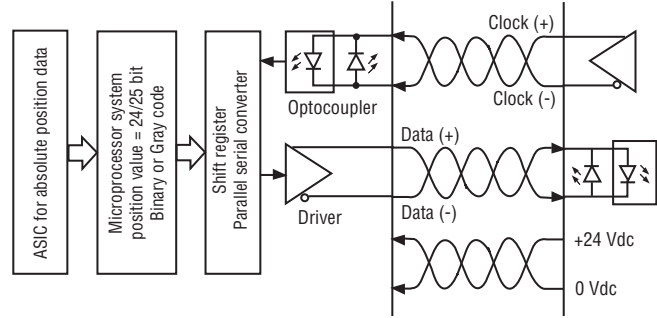

Figure 3. Logic Diagram

Sensor dimension references

Drawings are for reference only, contact applications engineering for tolerance specific information.

A robust aluminum extrusion forms the sensor housing containing the sensing element and electronics. The position magnet moves along the top of the profile extrusion housing.

MODEL EP

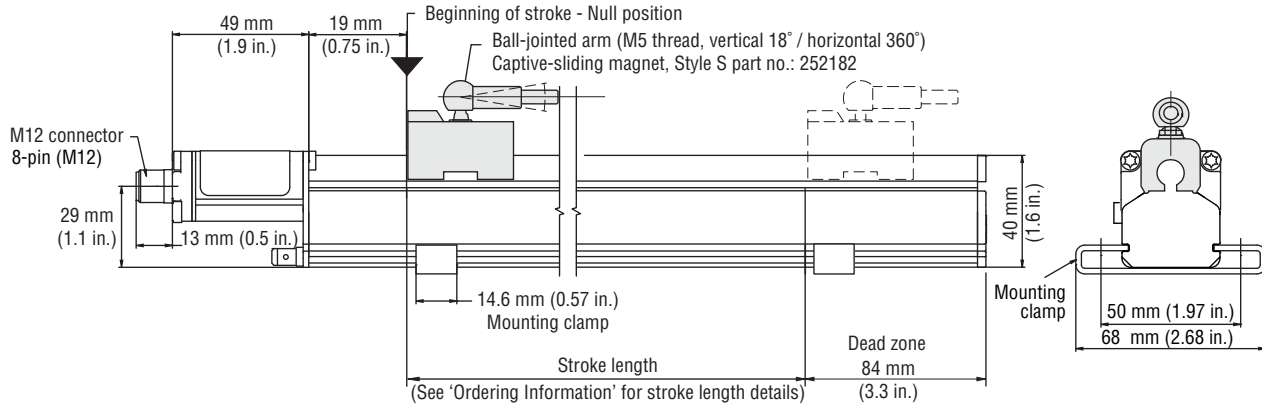

Figure 4. E-Series model EP sensor dimension reference (Shown with Style S captive-sliding magnet)

MODEL EL

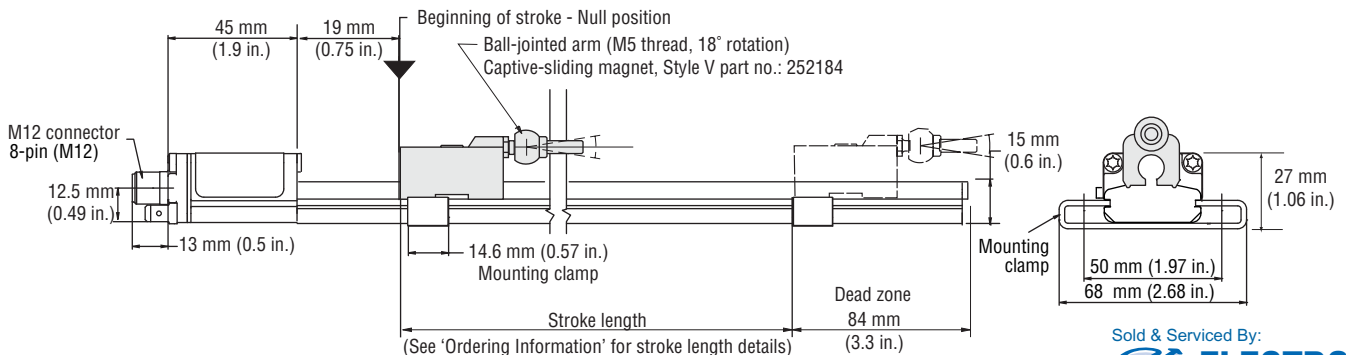

Figure 5. E-Series model EL sensor dimension reference (Shown with Style V captive-sliding magnet)

Sold & Serviced By:

ELECTROMATE

Toll Free Phone (877) SERV098

Toll Free Fax (877) SERV099

www.electromate.com

sales@electromate.com

E-Series Models EP and EL Sensors
Sensor Dimension References

Sensor dimension references

MODEL EP

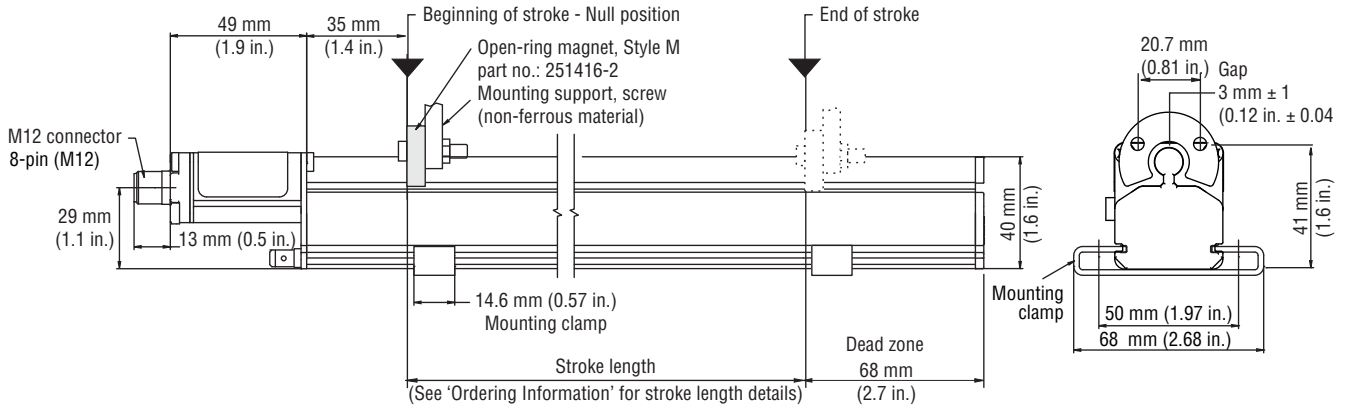

Figure 4. E-Series model EP sensor dimension reference (Shown with Style M open-ring magnet)

MODEL EP

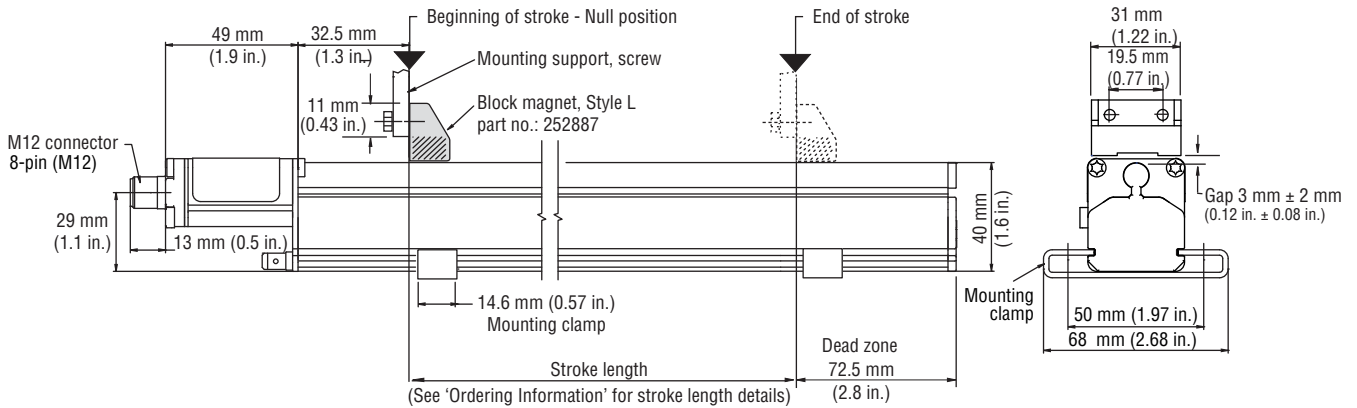

Figure 5. E-Series model EP sensor dimension reference (Shown with Style L block magnet)

Sold & Serviced By:



Toll Free Phone (877) SERV098

Toll Free Fax (877) SERV099

www.electromate.com

sales@electromate.com

Standard magnet selections (Models EP and EL)

Selection of position magnets







A choice of four standard magnet mounting configurations are available for E-Series models EP and EL sensors; A 'captive-sliding' magnet (Styles S or V), or an 'open-ring' magnet (Style M), or the 'block' magnet (Style L). Captive-sliding magnets utilize slide bearings of special material that reduce friction, and if required, help mitigate dirt build up. The slide bearings are designed to operate dry, requiring no external lubrication or maintenance.

The Style M 'open-ring' magnet can be used for the Model EP sensor, it mounts on the moving machine part and travels just above the sensor's profile extrusion. The open-ring magnet requires a minimum distance away from ferrous metals to allow proper sensor output. It must be mounted using non-ferrous screws and a non-ferrous support bracket, or utilize a non-ferrous spacer of at least 5 mm (0.2 in.) thickness.

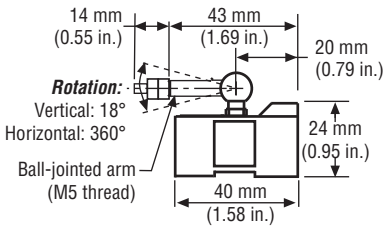
The Style L 'block' magnet (part no.: 252887), mounts on the moving machine part and travels just above the sensor's extrusion. The magnet can be mounted using ferrous metal screws on a customer supplied mounting plate or flat surface of the machine's moving part. The mounting plate or machine's moving part can not extend beyond 11 mm (0.43 in.) from the top of the magnet, unless it is made of non-ferrous material. The magnet should be installed in a perpendicular orientation relative to the top surface of the sensor extrusion. Optimal performance is achieved when this orientation remains consistent throughout the full measurement stroke range.

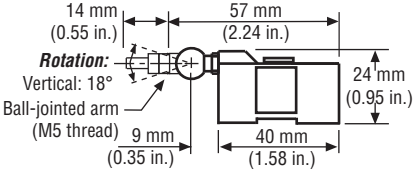
POSITION MAGNET SELECTIONS (All magnets must be ordered separately)

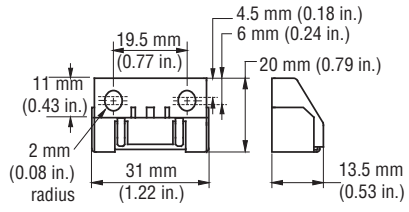
(Drawing dimensions are for reference only)

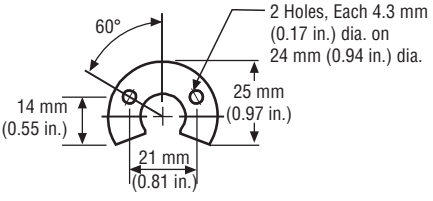
Magnet / accessory dimensions	Description	Part number
 	<p>Captive-sliding magnet, Style S For models EP and EL profile-style sensors Material: GFK, magnet hard ferrite Weight: Approx. 30 g Operating temperature: -40 °C to +75 °C</p>	252182
 	<p>Captive-sliding magnet, Style V For models EP and EL profile-style sensors Material: GFK, magnet hard ferrite Weight: Approx. 30 g Operating temperature: -40 °C to +75 °C</p>	252184
 	<p>Block magnet, Style L For models EP and EL profile-style sensors This magnet may influence the sensor performance specifications for some applications.</p>	252887
 	<p>Open-ring magnet, Style M I.D.: 13.5 mm (0.53 in.) O.D.: 33 mm (1.3 in.) Thickness: 8 mm (0.31 in.) Operating temperature: -40 °C to 100 °C For model EP profile-style sensors. This magnet may influence the sensor performance specifications for some applications.</p>	251416-2

Sold & Serviced By:



Toll Free Phone (877) SERV098

Toll Free Fax (877) SERV099

www.electromate.com

sales@electromate.com

**E-Series Models EP and EL Sensors
Mounting, Connections and Wiring**

Sensor mounting (Models EP and EL)

SENSOR MOUNTING CLAMPS

E-Series models EP and EL sensors are mounted onto the machine with moveable mounting clamps. Mounting clamps slide into side grooves and should be evenly distributed along the sensor extrusion to best secure the sensor for each particular application.

Notes:

- Models EP and EL sensors include two mounting clamps, (part number 403508), for stroke lengths up to 1250 mm (50 in.). One additional mounting clamp is included for stroke lengths over 1250 mm (50 in.) and for each additional 500 mm (20 in.).
- MTS recommends using 10-32 cap screws (customer supplied) at a maximum torque of 44 in. lbs. when fastening mounting clamps.

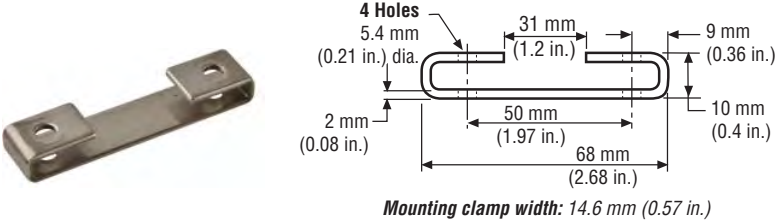
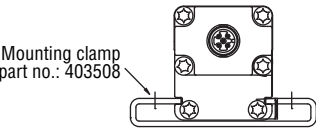
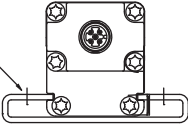
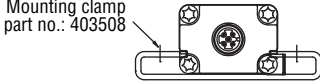
Models EP and EL sensor mounting and installation reference	Mounting method	Part number
 	<p>Mounting clamp Sensor mounting for sensor models EP and EL</p>	403508
<p><i>Model EP mounting</i></p> 	<p><i>Model EL mounting</i></p> 	<p>Mounting configuration using mounting clamp and screws</p> <p><i>Mounting clamp, part number 403508</i></p>

Connections and wiring (Model EP and EL)

SENSOR INTEGRAL CONNECTOR (D84) PINOUT/WIRE COLOR CODES

The E-Series models EP and EL sensors connect directly to a controller or interface module with a male, 8-pin integral connector and an extension cable as described in 'Table 1'.

Attention:

The sensors aluminum housing has an anodic coating which prevents the sensor's mounting clamps from providing the appropriate grounding. A grounding lug (see 'Figure 6') is provided near the connector end of the sensor for a convenient connection to earth ground. The appropriate grounding of the cable shield is also required at the controller end.



Integral D84 connector (male) as viewed from the end of the sensor

Pin no.	Extension cable wire color	Signal/function Start/Stop outputs
1	White	Clock (+)
2	Brown	Clock (-)
3	Green	Data (+)
4	Yellow	Data (-)
5	Gray	No connection
6	Pink	No connection
7	Blue	+24 Vdc
8	Red	DC ground (for power return)

Table 1. Integral D84 sensor connector

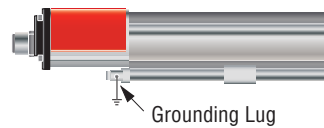

Figure 6. Grounding lug location.

Sold & Serviced By:



Toll Free Phone (877) SERV098
Toll Free Fax (877) SERV099
www.electromate.com
sales@electromate.com

**E-Series Models EP and EL Sensors
Cable Connector and (M12) Cord Set Options**

MATING CABLE CONNECTOR OPTIONS FOR (D84) CONNECTOR TYPES *(Photo and drawing dimensions are for reference only)*

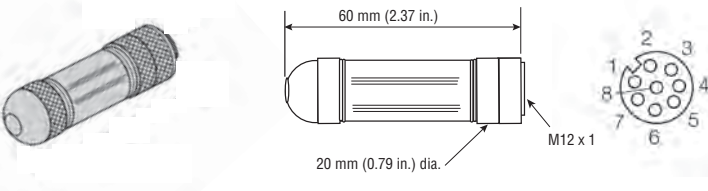
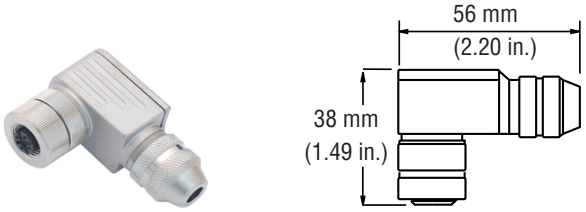
Connector and dimensions	Description	Part number
	<p>Female cable connector, straight exit (Field installable) 8-Pin (D84) Mates with standard male (M12) integral connector Termination: Screw terminals Cable gland: PG9 for 6-8 mm dia. cable Ingress protection: IP67</p>	370694
	<p>Female cable connector, 90° exit (Field installable) 8-Pin (D84) Mates with standard male (M12) integral connector Termination: Screw terminals Cable gland: PG9 for 6-8 mm dia. cable Ingress protection: IP67</p>	370699

M12 CORD SETS *(Photo and drawing dimensions are for reference only)*

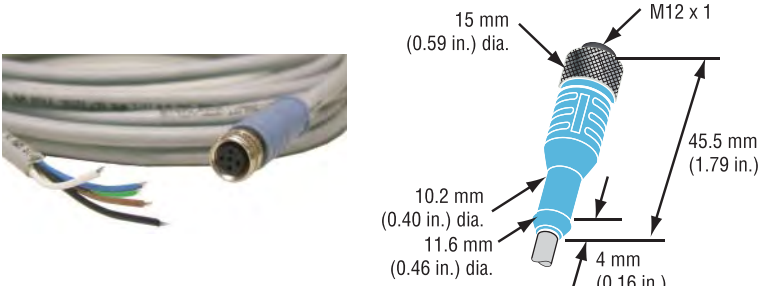
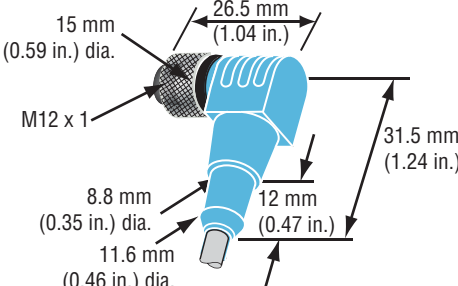
	<p>M12 Cord set, female connector, straight exit 8-Pin (M12) mates with standard male (D84) integral connector Ingress protection: IP67 Cable: 5 m, shielded, pigtail end</p>	370674
<p><i>(Image not available)</i></p> 	<p>M12 Cord set, Female, Connector 90° Exit 8-Pin (M12) mates with standard male (D84) integral connector Ingress protection: IP67 Cable: 5 m, shielded, pigtail end</p>	370676

Sold & Serviced By:



Toll Free Phone (877) SERV098

Toll Free Fax (877) SERV099

www.electromate.com

sales@electromate.com

E-Series Models EP and EL Sensors, SSI Output

Ordering Information

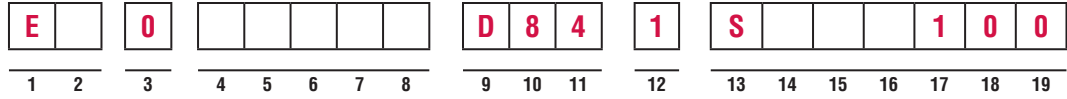

(Use the order matrix above to configure your Model EP or EL sensor order number)

SENSOR MODEL _____ = E **1 - 2**

- EP** = E-Series model EP profile-style sensor (Magnet(s) must be ordered separately)
- EL** = E-Series model EL low-height profile-style sensor (Magnet(s) must be ordered separately)

HOUSING STYLE _____ = 0 **3**

- 0** = (Zero) EP and EL sensors do not have housing options or magnet types included in the standard model number. Magnets must be purchased separately by part number. Refer to 'Standard magnet selections (Models EP and EL)' in this document for part numbers.

STROKE LENGTH _____ = **4 - 8**

- _____ **M** = Millimeters (Encode in 25 or 50 mm increments as indicated in 'Stroke length notes' below).
- _____ **U** = Inches (Encode in 1 or 2 in. increments as indicated in 'Stroke length notes' below).
(Digit for tenths of inches is always '0').

Stroke Length Notes:

Stroke length ranges:
M = 50 mm to 2500 mm
U = 2 in. to 100 in.

The increment size between standard stroke lengths vary as shown below:

Stroke length (mm)	Ordering increment
≤ 500 mm	25 mm
> 500 mm and ≤ 2500 mm	50 mm
Stroke length (IN)	Ordering increment
≤ 20 in.	1 in.
> 20 in. and ≤ 100 in.	2 in.

SENSOR CONNECTION TYPES _____ = D 8 4 **9 - 11**

- D84** = 8-Pin (M12), male, (SSI output)

INPUT VOLTAGE _____ = 1 **12**

- 1** = + 24 Vdc (+20%, -15%), standard

OUTPUT _____ = S 1 0 0 **13-19**

- S** _____ = SSI output - Enter the 6-digit output code (1-6) defined by the selections below:

[1] [2] [3] [4] [5] [6]

- | | | | |
|--|---|--|---|
| <p>[14] Data length</p> <p>1 = 25 bits</p> <p>2 = 24 bits</p> | <p>[15] Output format</p> <p>B = Binary</p> <p>G = Gray code</p> | <p>[16] Resolution</p> <p>3 = 0.05 mm</p> <p>4 = 0.1 mm</p> <p>5 = 0.02 mm</p> | <p>[17] Performance</p> <p>1 = Standard</p> |
|--|---|--|---|

- [18] [19] Signal options (scale orientation)**
- 00** = Measuring direction forward, async